



## Yuasa Technical Data Sheet

### Yuasa M27-90S - Marine Batteries

#### Performance

Voltage	12V
Capacity (20-hour)	90Ah
Cold Cranking Amps (EN1)	720A

#### Dimensions

Length	304mm
Width	173mm
Height	225mm

#### Weights & Measures

Mean Weight with Acid	21.2kg
-----------------------	--------



#### Container Features

Case Type	GR27 BCI
Cell Layout	1
Hold Down	B1
State of Charge Indicator	✓
Handles	✓
End Venting	✓
Semi-Traction Features	✓
Lid Lid	SMF Double Lid

#### Technology

Flame Arrestor	✓
Technology	Ca/Ca
Separator	PE
Recommended Charge Rate	5A

#### Terminal Type

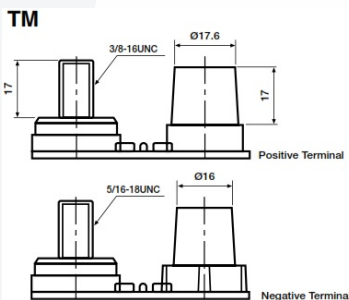

#### Cell Assembly Layout

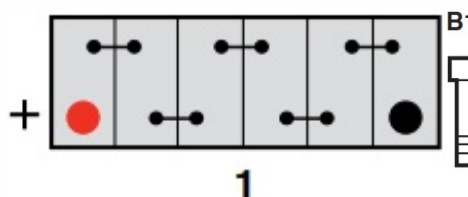

#### Battery Hold-down

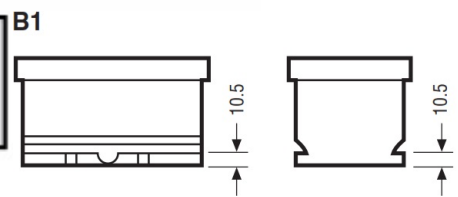

Data Sheet generated on 05/01/2020 - E&OE